

NARATIF BAHARU UKM  
**UNIVERSITI  
ATAN KITA**

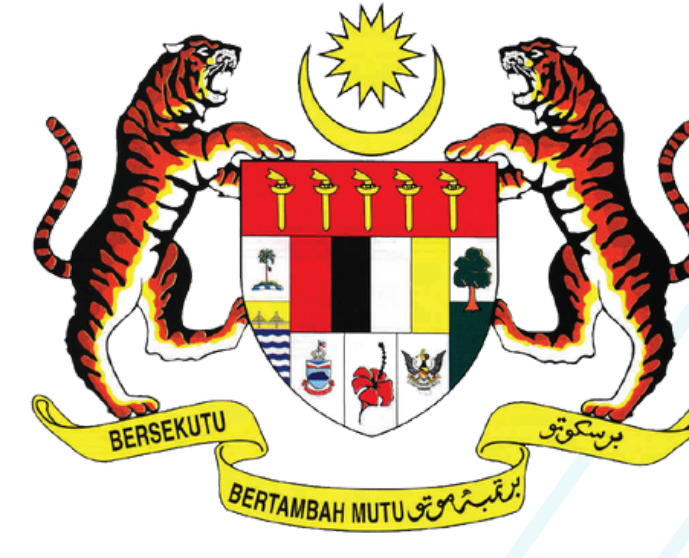

MINISTRY OF EDUCATION  
GENIUS DIVISION



# GMUN 2023

GENIUS MODEL UNITED NATIONS CONFERENCE

## DELEGATE HANDBOOK





# TABLE OF CONTENTS

● <b>General Information</b>	<b>3</b>
● <b>Directions to Our Campus</b>	<b>4</b>
● <b>Dress Code</b>	<b>5</b>
● <b>Conference Venues</b>	<b>6</b>
● <b>Luggage Storage</b>	<b>8</b>
● <b>Wi-Fi Details</b>	<b>9</b>
● <b>Programme Schedule</b>	<b>10</b>
● <b>Ceremony Schedule</b>	<b>13</b>
● <b>Campus Masterplan</b>	<b>15</b>



# GENERAL INFORMATION

## Registration

The registration counters are located in the Auditorium Lobby and will be open starting at 12.30 PM. Our Registration Counters will be open throughout the Opening Ceremony, any latecomers will still have to register and check in at our Counters.

## Basic Rules & Regulations

You will be **required to sign** the Terms and Conditions of GMUN '23 during the registration before the Opening Ceremony. Participants must adhere to the Code of Conduct and respect the rules and regulations stated at all times. Any failure to adhere might result in removal, termination, or a permanent ban from any future Conferences.

## MUN 101 Workshop

Malaysian Youth Association for Diplomacy and Policy (MYADP) will be delivering an MUN 101 Workshop (HMUN Rules of Procedure) from 5-5.30 PM right after the Opening Ceremony at the Auditorium. All participants are invited to join.

## Tasty Treats

Bring some money along, there'll be stalls and food trucks throughout the 3 busy days to fuel your diplomatic brains!



# DIRECTIONS TO OUR CAMPUS

On the day of our conference, you are advised to follow the blue route (pictured below). Please refrain from following the grey route as it is not vehicle-friendly. Upon arriving at Universiti Kebangsaan Malaysia (hereafter referred to as UKM), you may follow the images attached below or the following linked Google Maps routes to reach the Conference venue: through Gate 1 or Gate 2.

**Our address is as follows:**

**Pusat GENIUS@Pintar Negara,  
Universiti Kebangsaan Malaysia,  
43600 Bangi,  
Selangor,  
Malaysia.**

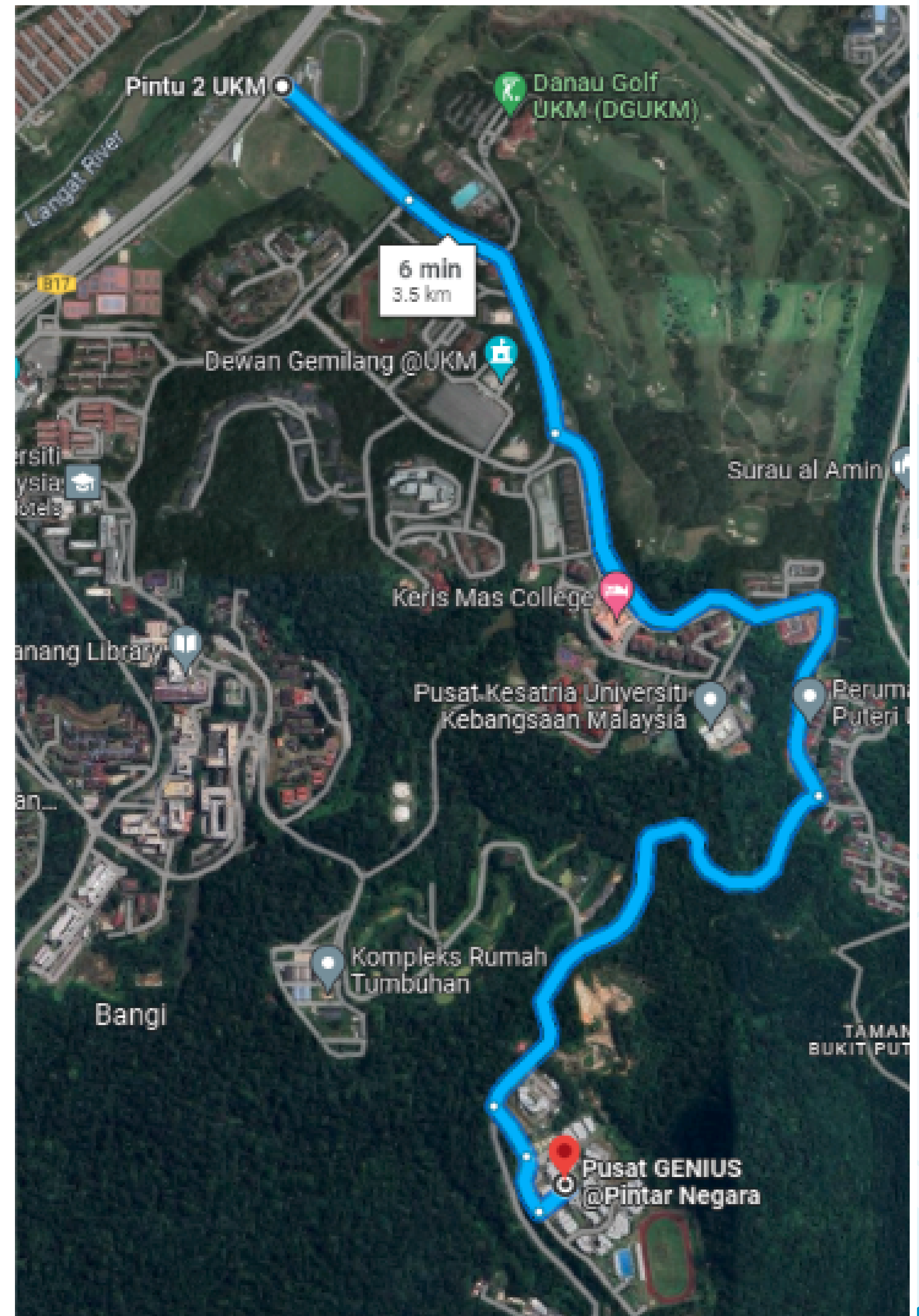
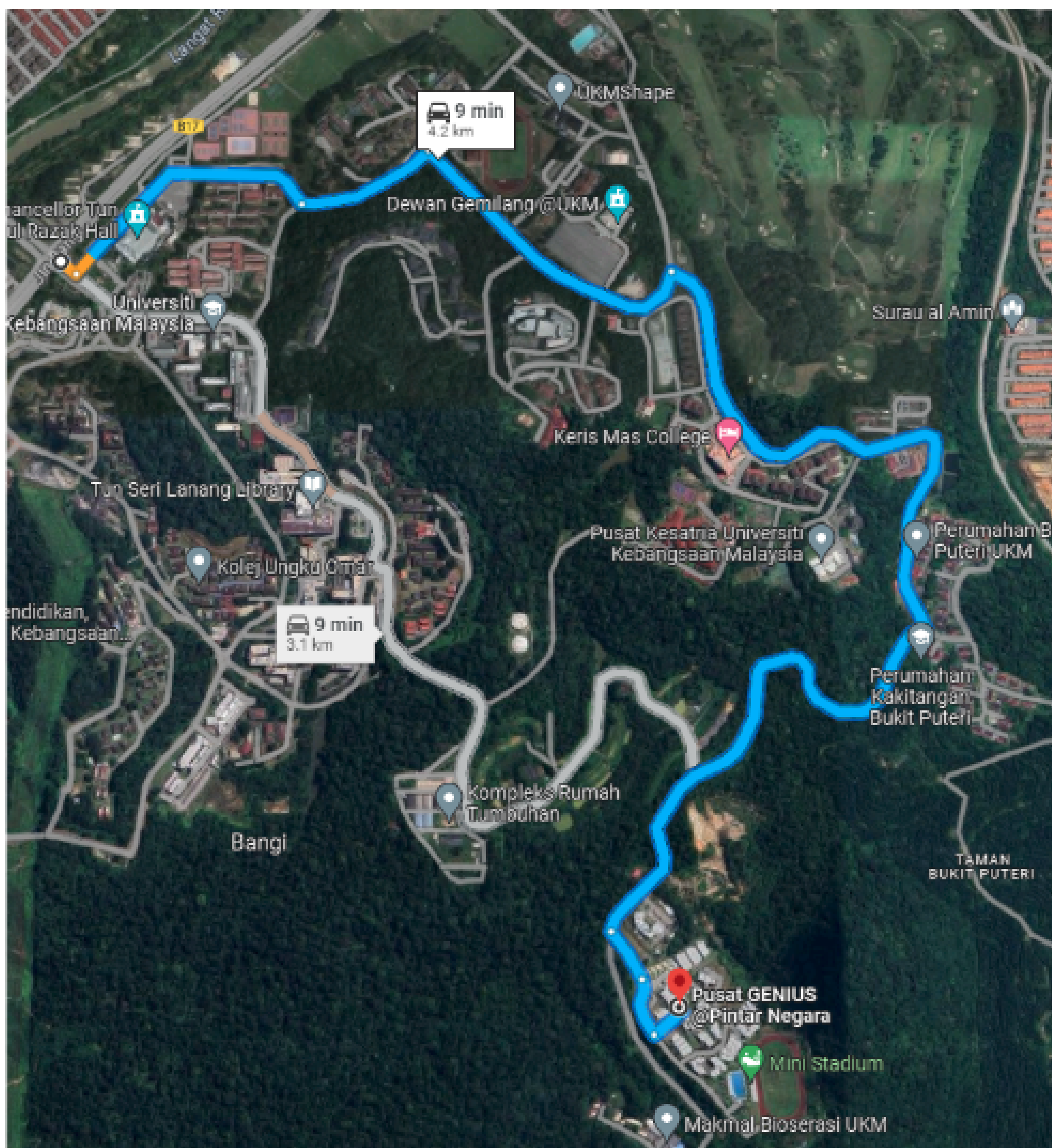



# DRESS CODE

The dress code set is **formal business attire** and adhering to the guidelines set by the National University of Malaysia (UKM). It is reminded that you dress **appropriately** and respectfully.

**Knee-length** skirts are allowed.





# CONFERENCE VENUES

Below is the full list of the council venues:

<b>UNEP</b>	<b>Class 9 Block B &amp; Class 10 Block B</b>
<b>UNWOMEN</b>	<b>Class 11 Block B &amp; Class 12 Block B</b>
<b>UNHRC</b>	<b>Class 11 Block B &amp; Class 12 Block B</b>
<b>UNESCO</b>	<b>Class 7 Block B &amp; Class 8 Block B</b>
<b>ECOSOC</b>	<b>Class 1 Block B &amp; Class 2 Block B</b>
<b>DISEC</b>	<b>Class 3 Block B &amp; Class 4 Block B</b>
<b>UNSC</b>	<b>Meeting Room 2</b>
<b>Crisis</b>	<b>Language Lab 2</b>
<b>IPC</b>	<b>Class 1 Block A</b>



# CONFERENCE VENUES

Here are also venues around our campus that will be used during the Conference:

**Opening & Closing Ceremony**

**Auditorium**

**Dining Area**

**In front of the Auditorium**

**Advisor's Lounge**

**Library**

**Dinner on the Second Day,  
8th July 2023**

**Dining Hall**

**Meetup Mixer**

**Prayer Rooms**

**Dining Hall  
(Male)**

**Administration Block  
(Male and Female)**

**Hostel Block B  
(Female)**

**Luggage Storage**

**Gallery Room**



# LUGGAGE STORAGE

## ▶ **First Day, 7th July 2023**

For those who are **unable to check into** their accommodations prior to coming for the Conference and the Opening Ceremony, a **luggage storage area (Gallery Room)** is available for you to store your luggage. Our Volunteers will be there to assist you on the day. The Room will be open at the same time as the Registration Counters open.

## ▶ **Third-Day, 9th July 2023**

For those who must **check out early** (before 12 PM) on 9th July 2023, the same service will be available starting from the morning of the final day of the conference. You can securely store your luggage in the designated **luggage storage area (Gallery Room)**. Our dedicated volunteers will be present to assist you with the process. The storage area will remain accessible until the end of the conference, allowing you to enjoy the final day without the burden of carrying your luggage.





# WI-FI DETAILS

Please note that the reception at our campus is quite weak as our campus is located far from the nearest cell tower. In the meantime, you can use the free Wi-Fi in our campus. These are the steps to connect to the Wi-Fi.

- Connect to the MyUKM network.

- When prompted, click 'Connect with Guest Email'.

- Enter a valid email address and click 'Login'.

- A verification email will be sent to you. Click the 'Activate Email' button or you will be disconnected after 5 minutes.

- You're now free to use the free Wi-Fi! (some devices may require you to disconnect and reconnect after verification to access the Wi-Fi.)



# PROGRAMME SCHEDULE

You may refer to the latest schedule of the Conference on our [website](#).

## 7 July 2023, Friday

12:30pm - 3:15pm	Registration
3:30pm - 5:00pm	Opening Ceremony
5:00pm - 5:30pm	Briefing: MUN 101
5:30pm - 5:50pm	Prayers Break
6:00pm - 7:30pm	Council Session 1
7:30pm - 8:30pm	Dinner
8:30pm	Dismissal



# PROGRAMME SCHEDULE

**8 July 2023, Saturday**

8:00am - 8:30am	<b>Breakfast</b>
8:30am - 10:30am	<b>Council Session 2</b>
10:30am - 10:45am	<b>Break</b>
10:45am - 12:30pm	<b>Council Session 3</b>
1:00pm	<b>Lunch</b>
3:00pm - 5:00pm	<b>Council Session 4</b>
5:00pm - 5:15pm	<b>Break</b>
5:15pm - 7:15pm	<b>Council Session 5</b>
7:30pm - 8:30pm	<b>Dinner</b>
8:30pm - 10:00pm	<b>Meetup Mixer</b>
10:15pm	<b>Dismissal</b>



# PROGRAMME SCHEDULE

**9 July 2023, Sunday**

8:00am - 8:30am	<b>Breakfast</b>
8:30am - 10:30am	<b>Council Session 6</b>
10:30am - 10:45am	<b>Break</b>
10:45am - 12:30pm	<b>Council Session 7</b>
12:30pm	<b>Lunch</b>
2:20pm - 4:30pm	<b>Awards Ceremony</b>
4:30pm	<b>Goodbye</b>



# OPENING CEREMONY SCHEDULE

**7 July 2023, Friday**  
**3:30pm - 5:00pm**

3.00 p.m.	Arrival of Participants and Guests
3.30 p.m.	Arrival of Division Secretary, GENIUS Division, Ministry of Education of Malaysia, and VIPs
3.35 p.m.	Recitation of Doa
3.40 p.m.	Singing of Negaraku, Varsiti Kita & Anak Permata
3.50 p.m.	Speech by Wan Muhammad Daniel bin Wan Junaidi, Deputy Secretary General of GMUN 2023
4.00 p.m.	Welcoming Remarks by YBrs. Prof. Madya Dr Rorlinda binti Yusof, Director of GENIUS@Pintar National Gifted Centre, National University of Malaysia
4.10 p.m.	Opening Speech by YBrs. Dr. Normas binti Awang Division Secretary, GENIUS Division, Ministry of Education of Malaysia
4.20 p.m.	Montage Showing
4.25 p.m.	Keynote Speech by Ms. Tengku Aira Tengku Razif, Programme Analyst, United Nations Population Fund (UNFPA)
4.35 p.m.	Performance
4.55 p.m.	Token of Appreciation & Photography Session
5.00 p.m.	Briefing



# CLOSING CEREMONY SCHEDULE

**9 July 2023, Sunday  
2:20pm - 4:30pm**

2.20 p.m.	Arrival of Participants and Guests
2.40 p.m.	Arrival of Director of GENIUS@Pintar National Gifted Centre, National University of Malaysia and VIPs
2.45 p.m.	Recitation of Doa
2.50 p.m.	Singing of Negaraku, Varsiti Kita & Anak Permata
3.00 p.m.	Speech by <b>Lim Ke Wen &amp; Winnie Choong,</b> President & Deputy President of Malaysian Youth Association for Diplomacy and Policy (MyADP)
3.10 p.m.	Speech by Muhammad Syarif bin Mohd Shariful Azwan, Secretary General GMUN 2023
3.20 p.m.	Montage Showing
3.25 p.m.	Closing speech by <b>YBrs. Assoc. Prof. Dr Rorlinda binti Yusof,</b> Director of GENIUS@Pintar National Gifted Centre, National University of Malaysia
3.35 p.m.	Award Presentation
4.05 p.m.	Performance
4.25 p.m.	Photography Session
4.30 p.m.	End of GMUN 2023



NARATIF BAHARU UKM  
**UNIVERSITI ATAN KITA**

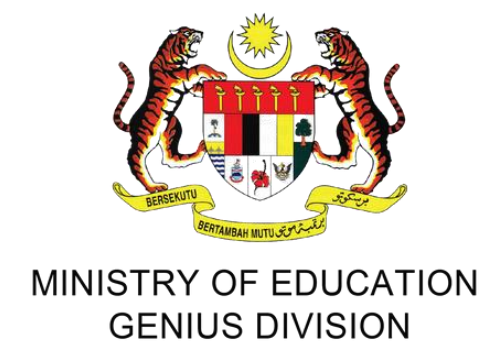

# Masterplan

# GENIUS@Pintar NATIONAL GIFTED CENTER NATIONAL UNIVERSITY OF MALAYSIA

LEGEND	
A	ADMINISTRATION BLOCK
LA	LABORATORY BLOCK A
LB	LABORATORY BLOCK B
CA	CLASSROOM BLOCK A
CB	CLASSROOM BLOCK B
AB	ACADEMICIAN BLOCK
HA	HOSTEL BLOCK A (FEMALE)
HB	HOSTEL BLOCK B (FEMALE)
HC	HOSTEL BLOCK C (MALE)
HD	HOSTEL BLOCK D (MALE)
CF	CAFETERIA
MH	MULTI-PURPOSE HALL
DH	DINING HALL
AD	AUDITORIUM
SP	SWIMMING POOL
SG	SPORTS GROUND
G	GUARD HOUSE
R	REFUSE CHAMBER



# GMUN 2023

GENIUS MODEL UNITED NATIONS CONFERENCE

**7-9**  
JULY  
2023 | BEYOND BORDERS:  
BRIDGING THE DIVIDE

Pusat GENIUS@Pintar Negara, Universiti Kebangsaan Malaysia

# Masterplan CLASSROOM BLOCK

# GENIUS@Pintar NATIONAL GIFTED CENTER NATIONAL UNIVERSITY OF MALAYSIA

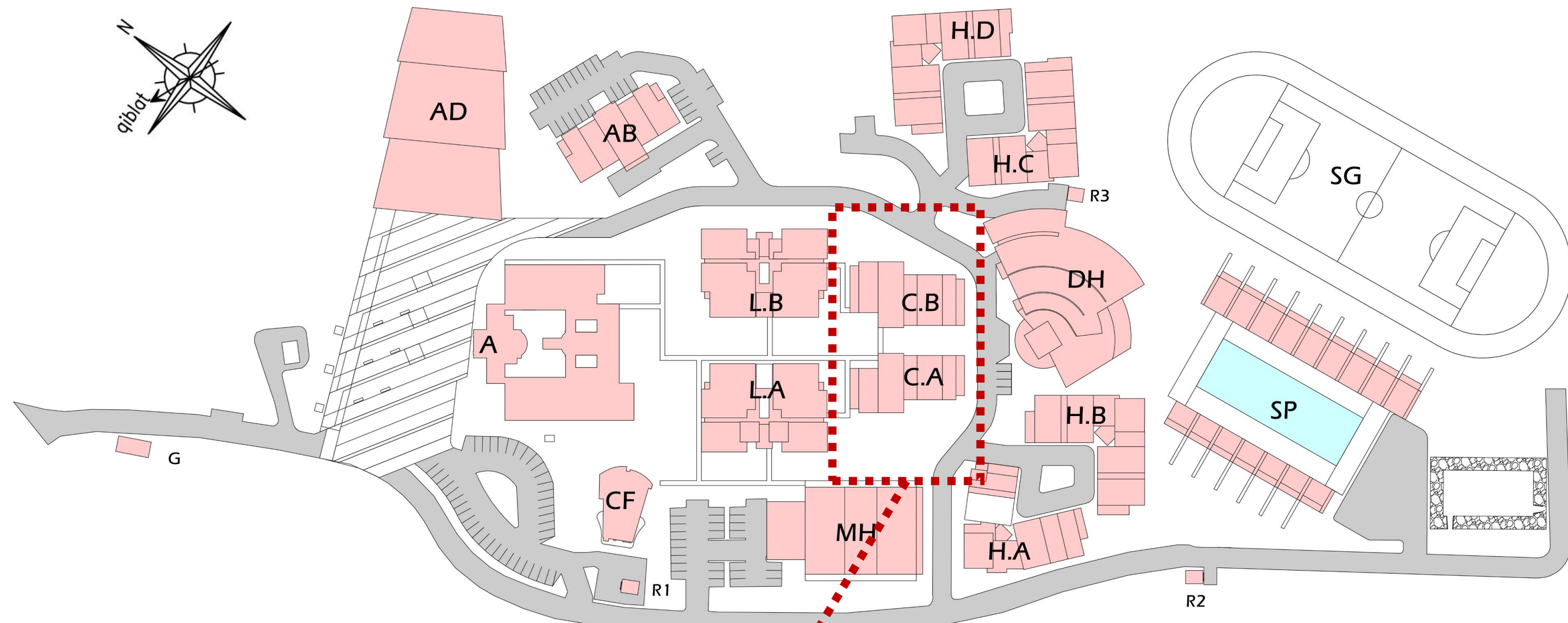

LEGEND				
BLOCK		SPACE		COUNCIL
C.A	CLASS BLOCK A	C1	Class 1	IPC
		C2	Class 2	ECOSOC
C.B	CLASS BLOCK B	C3	Class 3	DISEC
		C4	Class 4	UNHRC
		C5	Class 5	UNESCO
		C6	Class 6	UNEP
		C7	Class 7	UNWOMEN
		C8	Class 8	
		C9	Class 9	
		C10	Class 10	
		C11	Class 11	
		C12	Class 12	

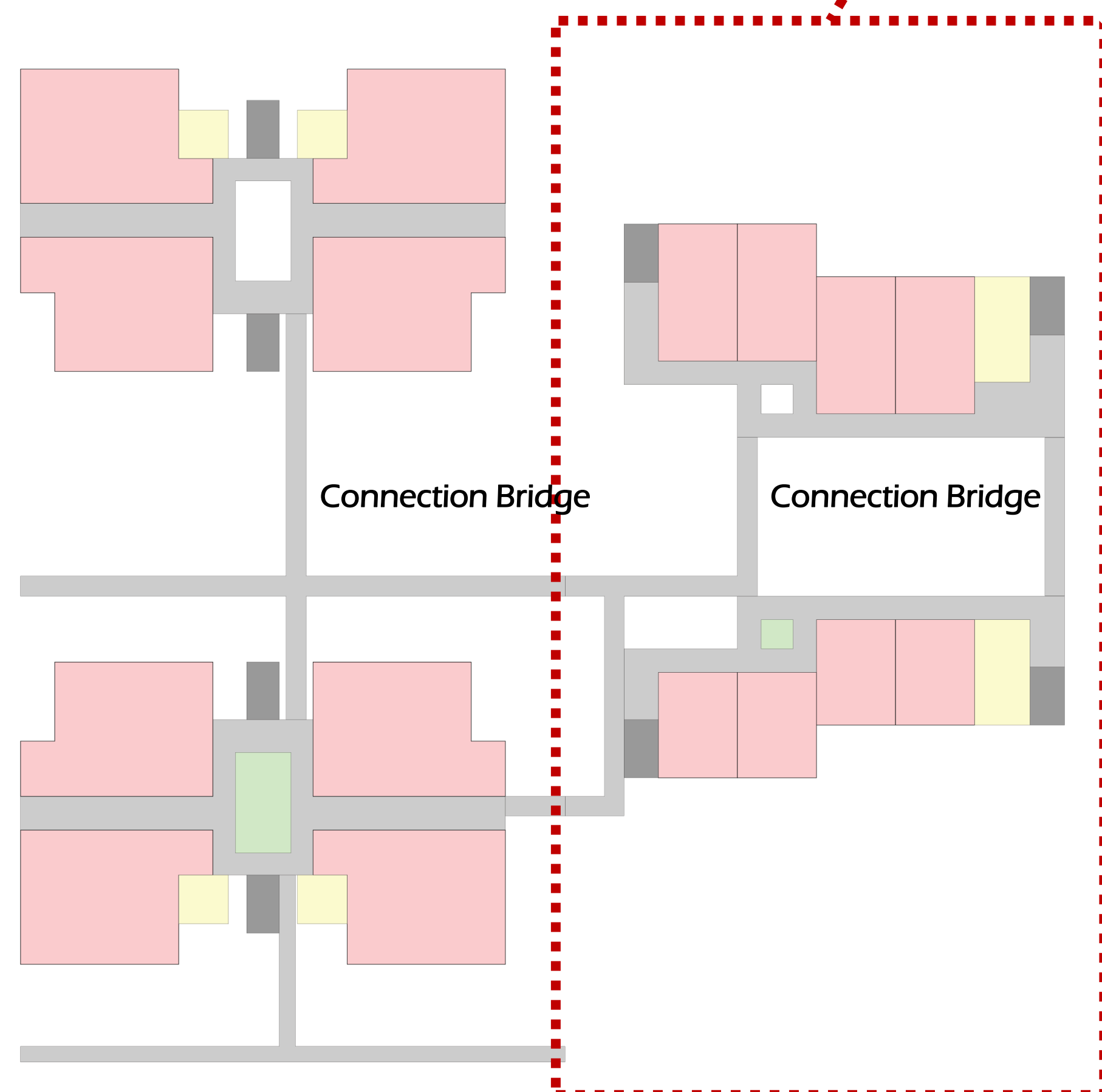

**GROUND FLOOR**

**1ST FLOOR**

**2ND FLOOR**

**CLASS BLOCK B**

**CLASS BLOCK A**

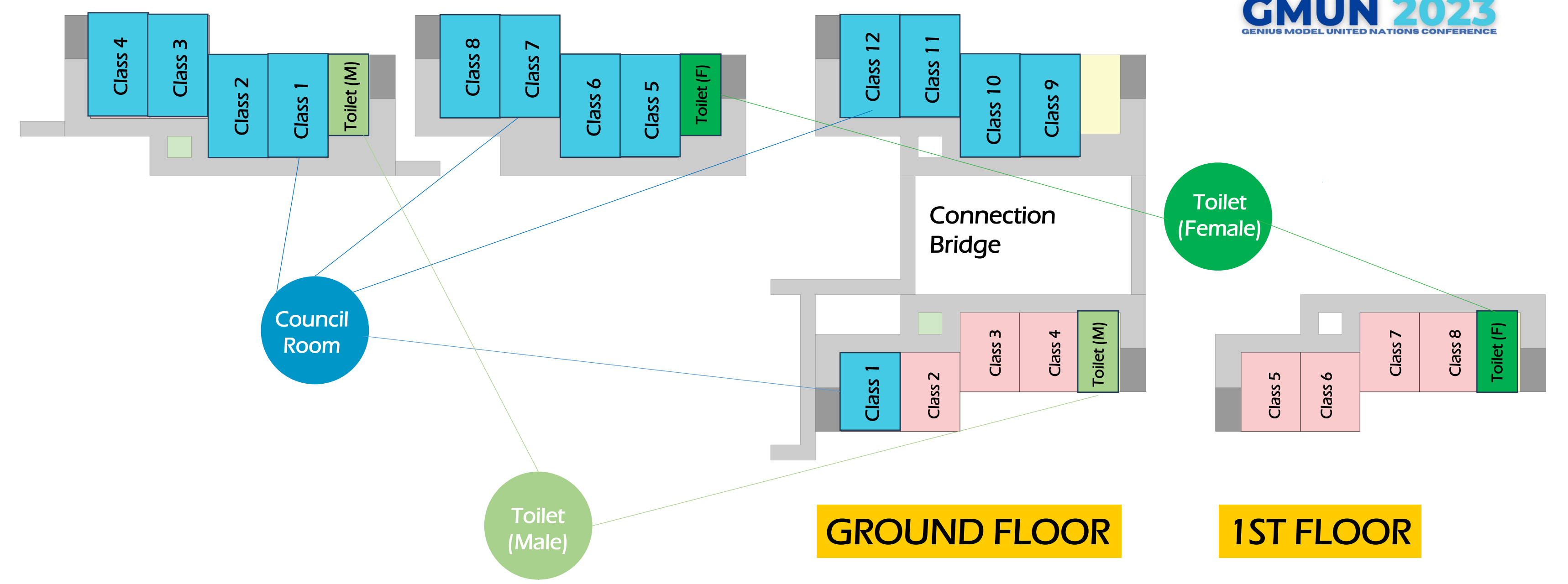

**GROUND FLOOR**

**1ST FLOOR**





**GMUN 2023**  
GENIUS MODEL UNITED NATIONS CONFERENCE

# Masterplan **LABORATORY BLOCK** GENIUS@Pintar NATIONAL GIFTED CENTER NATIONAL UNIVERSITY OF MALAYSIA

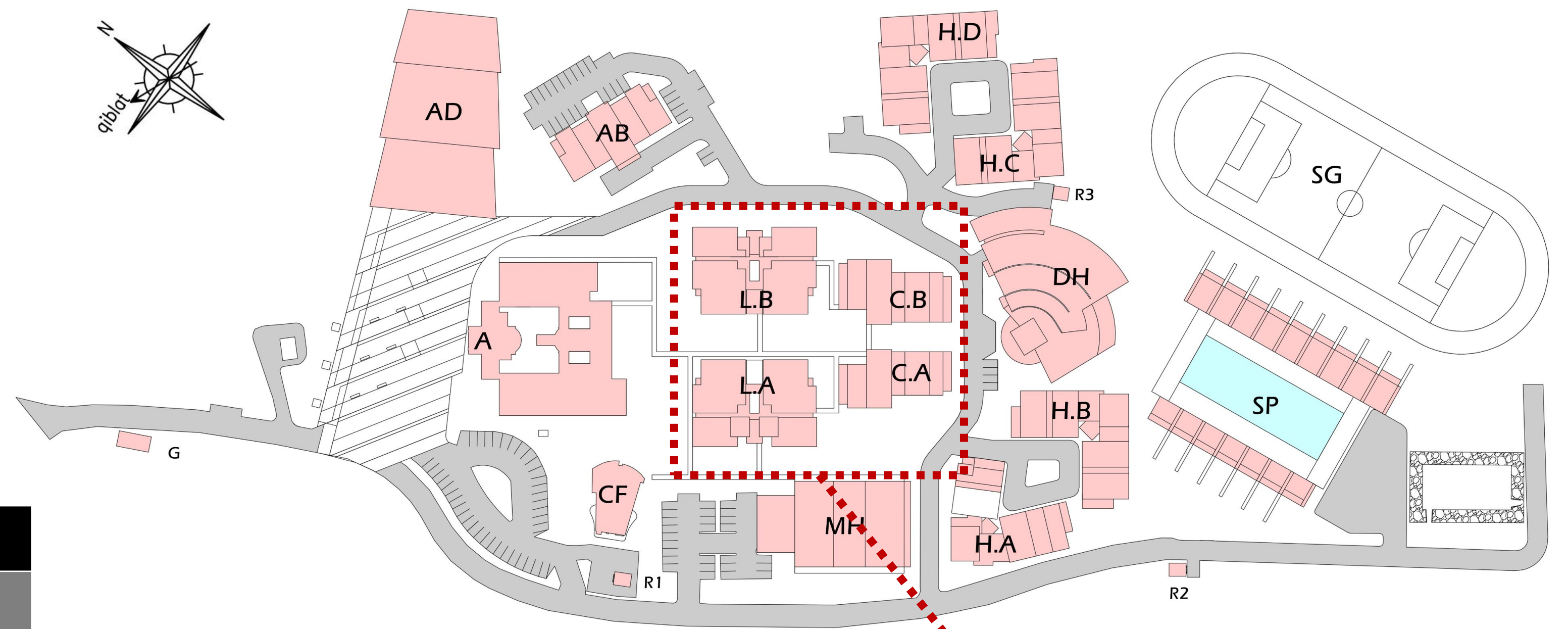

LEGEND		
BLOCK	SPACE	COUNCIL
L.B	LABORATORY BLOCK B	LL.2
	Language Lab 2	CRISIS

## GROUND FLOOR

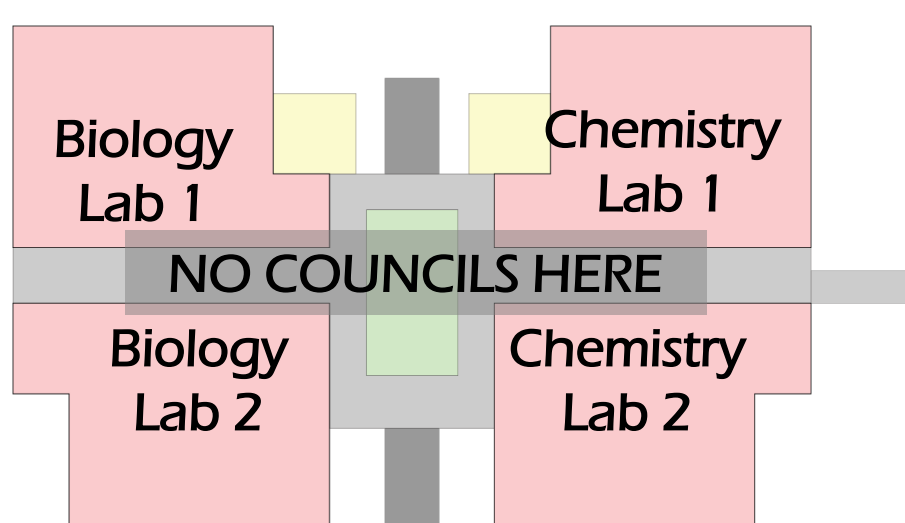

## 1ST FLOOR

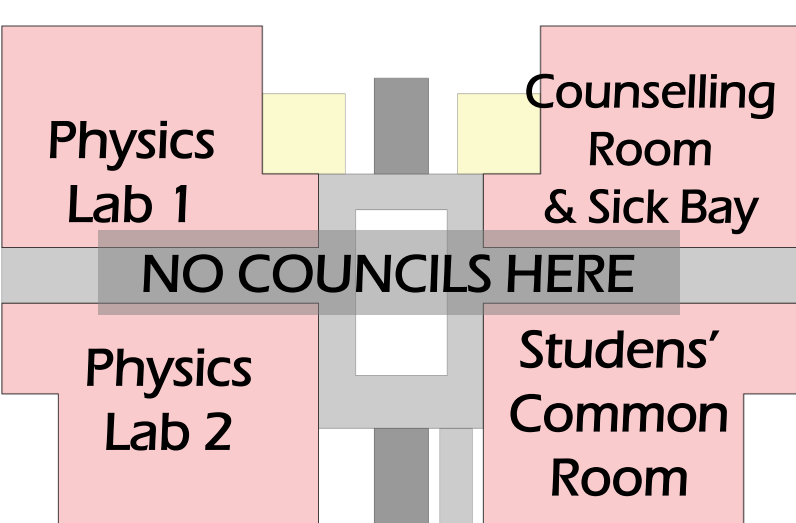

## 2ND FLOOR

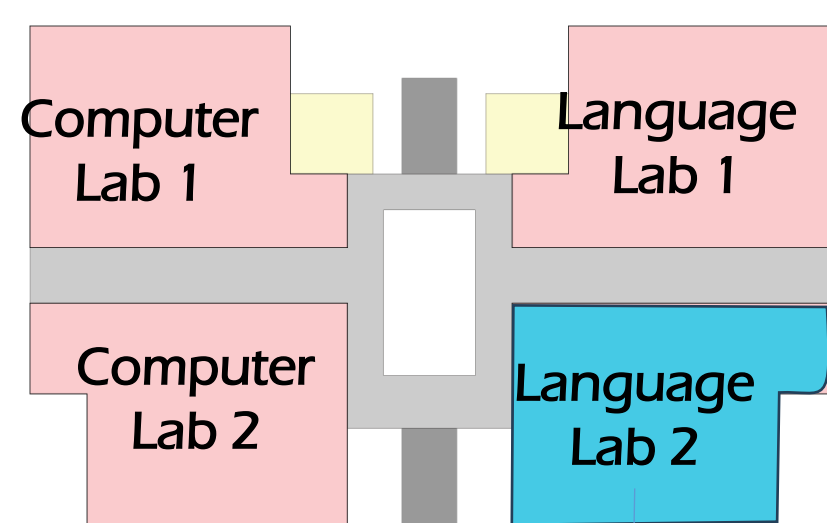

## 3RD FLOOR



**LABORATORY BLOCK B**

Connection Bridge

Council Room

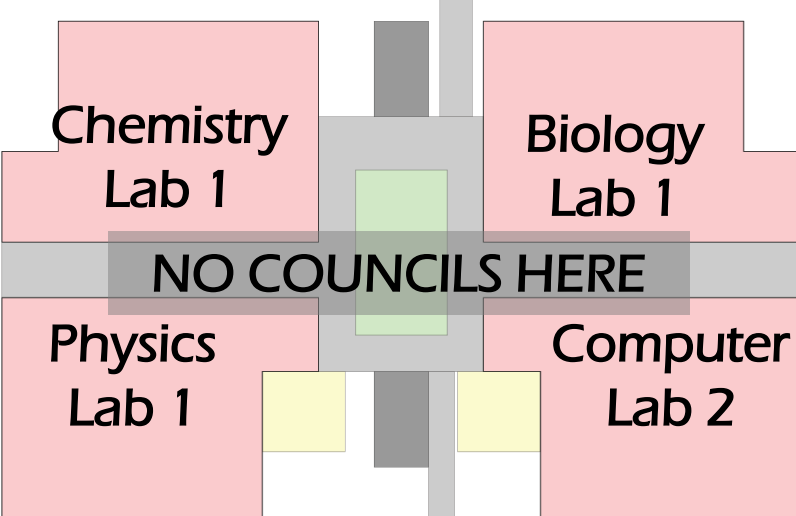

## GROUND FLOOR

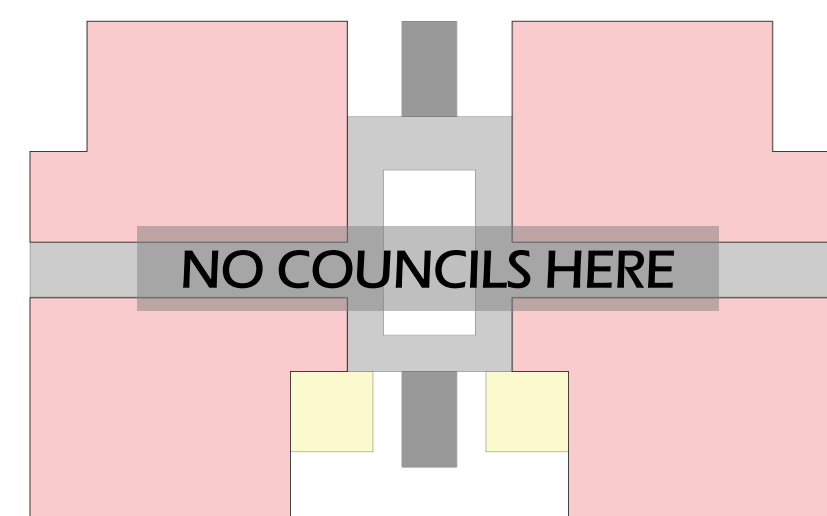

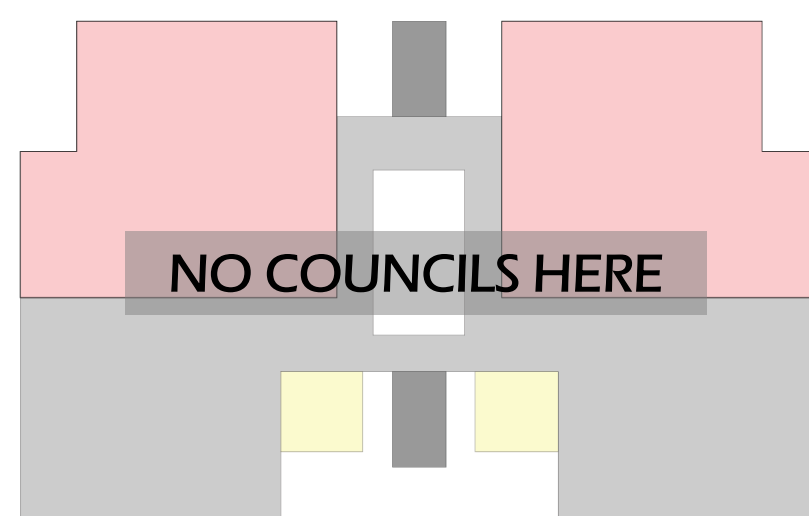

## 1ST FLOOR

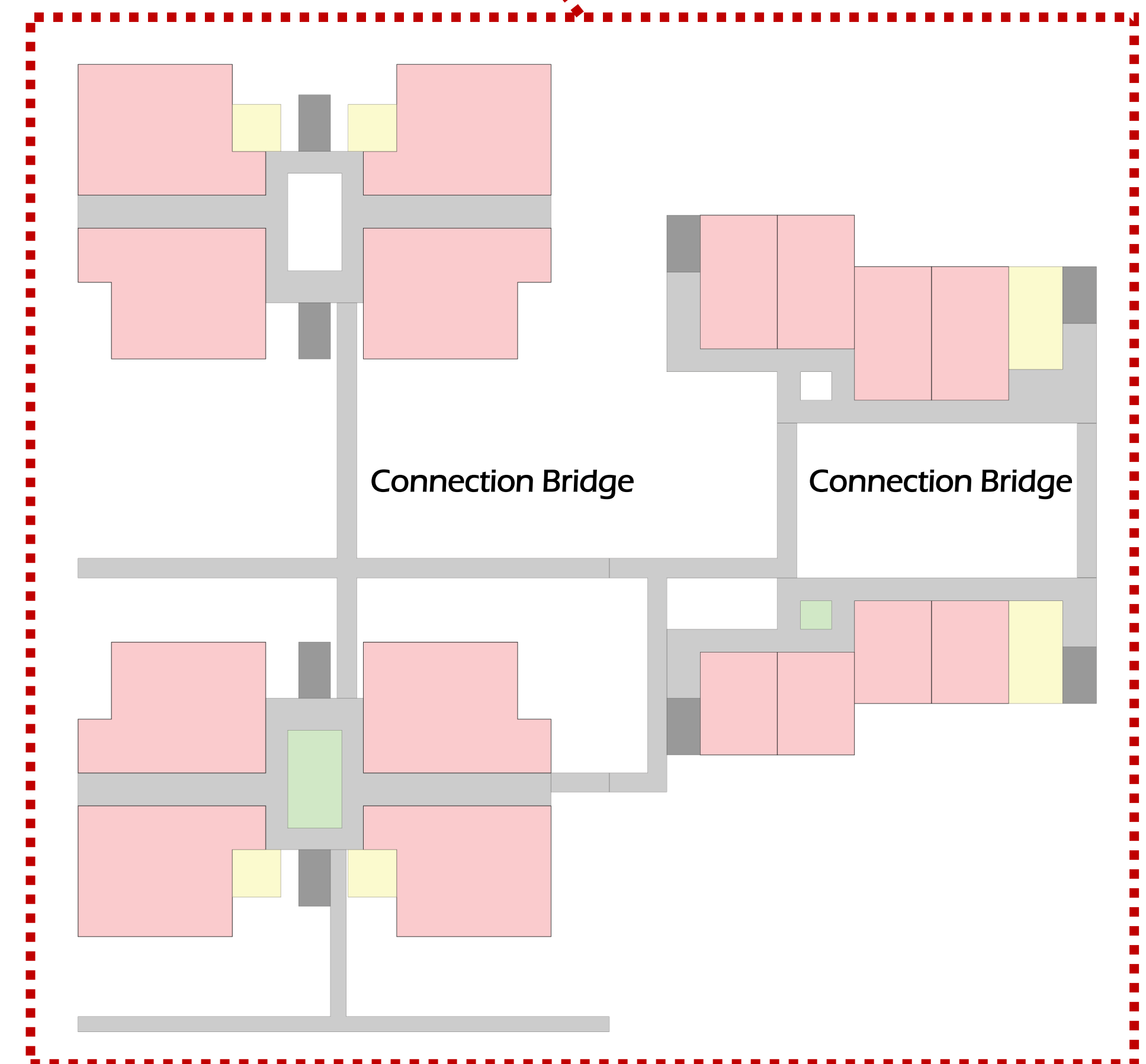

## 2ND FLOOR

**LABORATORY BLOCK A**





# Beyond Borders: Bridging the Divide

Contact us on:



<https://gmun.my>



[genmodelun@gmail.com](mailto:genmodelun@gmail.com)



@gmun\_23



@GMUN2023



# GMUN 2023

GENIUS MODEL UNITED NATIONS CONFERENCE